



■ Features

- Constant Power mode output
- Metal housing design with functional Ground
- Built-in active PFC function
- Class 2 power unit
- No load / Standby power consumption <0.5W
- IP67 rating for indoor or outdoor installations
- Function options: output adjustable via potentiometer
3 in 1 dimming (dim-to-off)
- Typical lifetime>50000 hours
- 5 years warranty

■ Applications

- LED street lighting
- LED architectural lighting
- LED bay lighting
- LED floodlighting
- Type “HL” for use in Class I, Division 2 hazardous (Classified) location.

■ Description

XLG-25 series is a 25W AC/DC LED driver featuring the constant power mode output. XLG-25 operates from 100~305VAC. Thanks to the high efficiency up to 88%, The entire series is able to operate between -40°C ~85°C wide case temperature range with air convection. The design of metal housing and IP67 ingress protection level allows this series to fit both indoor and outdoor applications. XLG-25 is equipped with various function options, such as dimming methodologies, so as to provide the optimal design flexibility for LED lighting system.

■ Model Encoding

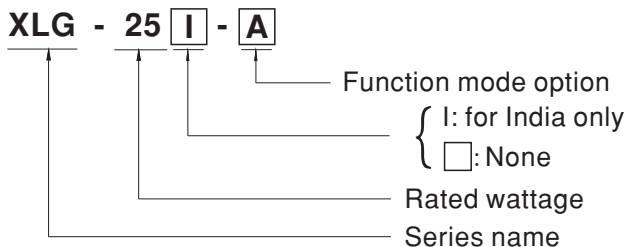

Type	IP Level	Function	Note
A	IP67	Io adjustable through built in potentiometer.	In Stock
AB	IP67	Io adjustable through built in potentiometer 3 in 1 dimming function (0~10Vdc, 10V PWM signal and resistance)	In Stock



SPECIFICATION

MODEL		XLG-25
OUTPUT	RATED CURRENT	700mA
	CONSTANT CURRENT REGION <small>Note.2</small>	22 ~54V
	RATED POWER <small>Note.5</small>	90VAC ~ 305VAC 25W
	CURRENT RIPPLE	5.0% max. @rated current
	OPEN CIRCUIT VOLTAGE (max.)	57V
	CURRENT ADJ. RANGE	0.25 ~ 1.05A
	SETUP, RISE TIME <small>Note.3</small>	500ms, 100ms/115VAC, 230VAC
INPUT	VOLTAGE RANGE <small>Note.5</small>	90 ~ 305VAC (Please refer to "STATIC CHARACTERISTIC" section)
	FREQUENCY RANGE	47 ~ 63Hz
	POWER FACTOR	PF ≥ 0.97/115VAC, PF ≥ 0.95/230VAC, PF ≥ 0.92/277VAC@full load (Please refer to "POWER FACTOR (PF) CHARACTERISTIC" section)
	TOTAL HARMONIC DISTORTION	THD < 10% (@load ≥ 50%/115VAC, 230VAC; @load ≥ 75%/277VAC) (Please refer to "TOTAL HARMONIC DISTORTION(THD)" section)
	EFFICIENCY (Typ.) <small>Note.10</small>	88%
	AC CURRENT	0.29A / 115VAC 0.15A / 230VAC 0.13A/277VAC
	INRUSH CURRENT(Typ.)	COLD START 50A(twidth=350μs measured at 50% Ipeak) at 230VAC; Per NEMA 410
	MAX. No. of PSUs on 16A CIRCUIT BREAKER	5 units (circuit breaker of type B) / 8 units (circuit breaker of type C) at 230VAC
	LEAKAGE CURRENT	<0.75mA / 277VAC
	NO LOAD / STANDBY POWER CONSUMPTION	No load power consumption <0.5W for A, <0.75W for I series Standby power consumption <0.5W for AB
PROTECTION	OVER POWER	110-150% Over Power Protection, recovers automatically after fault condition is removed
	SHORT CIRCUIT	Constant current limiting, recovers automatically after fault condition is removed
	OVER TEMPERATURE	Hiccup mode, recovers automatically after fault condition is removed
	INPUT OVER VOLTAGE <small>Note.8</small>	320 ~ 370VAC (Shut down output voltage when the input voltage exceeds protection voltage) can survive input voltage stress of 440Vac for 48 hours
ENVIRONMENT	WORKING TEMP.	Tcase=-40 ~ +85°C (Please refer to " OUTPUT LOAD vs TEMPERATURE" section)
	MAX. CASE TEMP.	Tcase=+85°C
	WORKING HUMIDITY	20 ~ 95% RH non-condensing
	STORAGE TEMP.	-40 ~ +80°C
	TEMP. COEFFICIENT	±0.03%/°C (0 ~ 60°C)
	VIBRATION	10 ~ 500Hz, 5G 12min./1cycle, period for 72min. each along X, Y, Z axes
SAFETY & EMC	SAFETY STANDARDS	UL8750(type"HL"), CSA C22.2 No. 250.13-12; ENEC AS/NZS IEC EN61347-1, AS/NZS EN61347-2-13 independent, EN62384; IP65 or IP67; GB19510.1, GB19510.14 approved
	WITHSTAND VOLTAGE	I/P-O/P:3.75KVAC I/P-FG:2.0KVAC O/P-FG:1.5KVAC
	ISOLATION RESISTANCE	I/P-O/P, I/P-FG, O/P-FG:100M Ohms / 500VDC / 25°C / 70% RH
	EMC EMISSION	Compliance to EN55015,EN61000-3-2 Class C (@load ≥ 50%); EN61000-3-3; GB17743, GB17625.1
OTHERS	EMC IMMUNITY	Compliance to EN61000-4-2,3,4,5,6,8,11; EN61547, light industry level (surge immunity Line-Earth 6KV, Line-Line 4KV)
	MTBF	1305.62 K hrs min. Telcordia SR-332 (Bellcore) 399.88Khrs min. MIL-HDBK-217F (25°C)
	DIMENSION	105*63*30mm (L*W*H)
NOTE	PACKING	0.41Kg;24pcs/ 10.5Kg/0.68CUFT for A-type 0.42Kg;24pcs/ 11Kg/0.68CUFT for AB-type
	<p>1. All parameters NOT specially mentioned are measured at 230VAC input, rated current and 25°C of ambient temperature.</p> <p>2. Please refer to "DRIVING METHODS OF LED MODULE".</p> <p>3. Length of set up time is measured at first cold start. Turning ON/OFF the driver may lead to increase of the set up time.</p> <p>4. De-rating may be needed under low input voltages. Please refer to "STATIC CHARACTERISTIC" sections for details.</p> <p>5. The driver is considered as a component that will be operated in combination with final equipment. Since EMC performance will be affected by the complete installation, the final equipment manufacturers must re-qualify EMC Directive on the complete installation again.</p> <p>6. This series meets the typical life expectancy of >50,000 hours of operation when Tcase, particularly (Tc) point (or TMP, per DLC), is about 70°C or less.</p> <p>7. Please refer to the warranty statement on MEAN WELL's website at http://www.meanwell.com</p> <p>8. Only for XLG-25 I series</p> <p>9. The ambient temperature derating of 3.5°C/1000m with fanless models and of 5°C/1000m with fan models for operating altitude higher than 2000m(6500ft).</p> <p>10. Only for XLG-25-A</p> <p>11. For any application note and IP water proof function installation caution, please refer our user manual before using.</p> <p>https://www.meanwell.com/Upload/PDF/LED_EN.pdf</p>	

■ Block Diagram

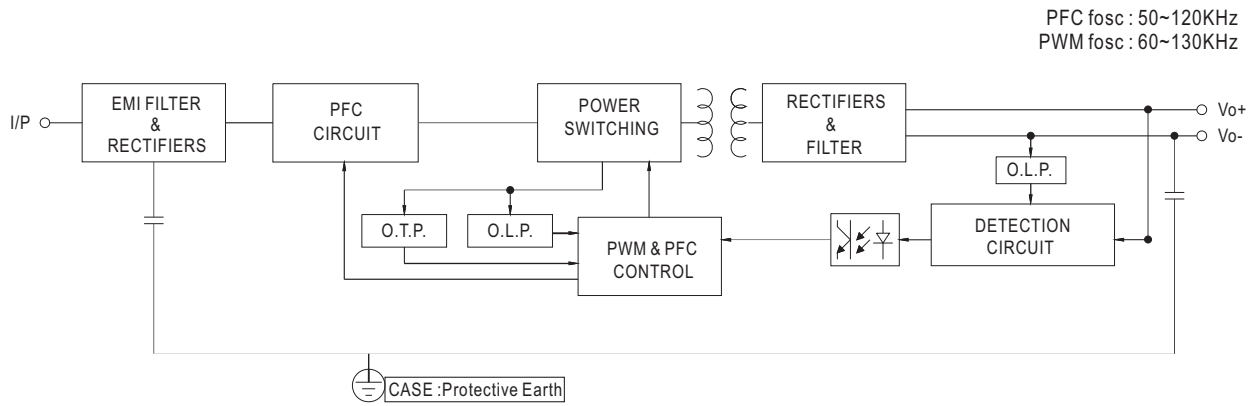

■ DRIVING METHODS OF LED MODULE

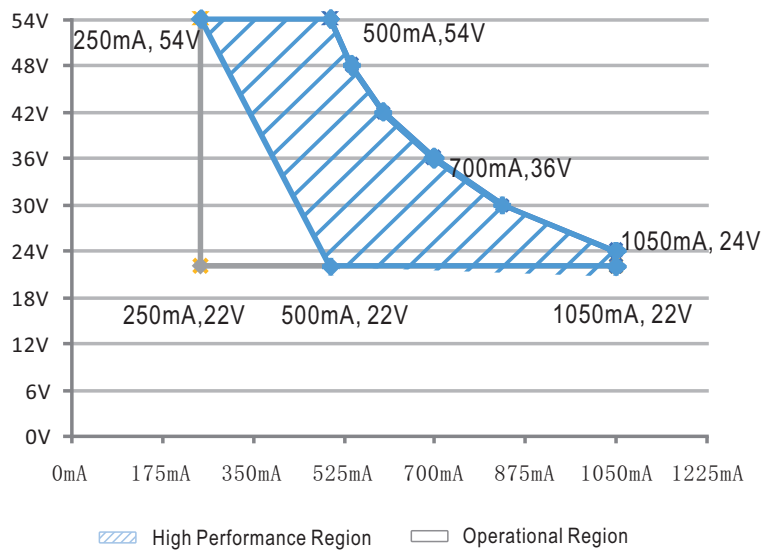

■ DIMMING OPERATION

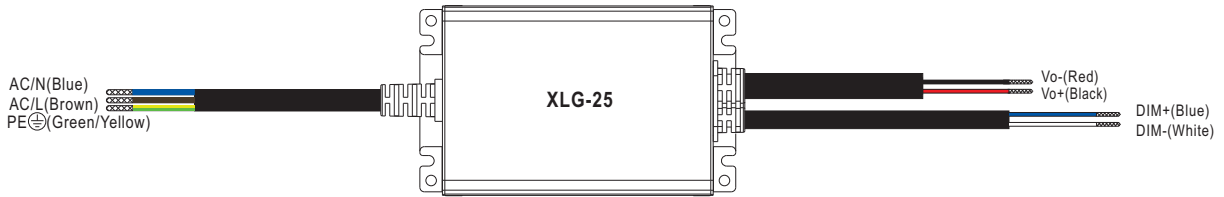

※ 3 in 1 dimming function (for AB-Type)

- Output constant current level can be adjusted by applying one of the three methodologies between DIM+ and DIM-: 0 ~ 10VDC, or 10V PWM signal or resistance.
- Direct connecting to LEDs is suggested. It is not suitable to be used with additional drivers.
- Dimming source current from power supply: 100 μ A (typ.)

◎ Applying additive 0 ~ 10VDC

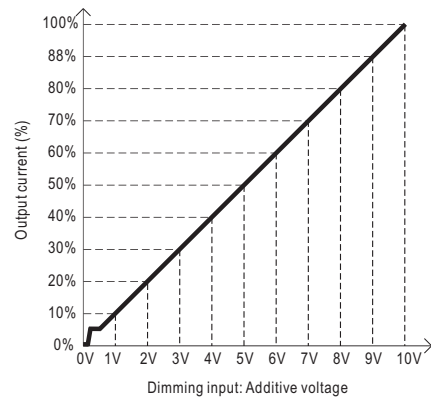
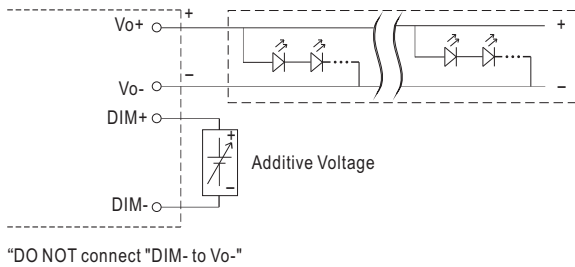

◎ Applying additive 10V PWM signal (frequency range 100Hz ~ 3KHz):

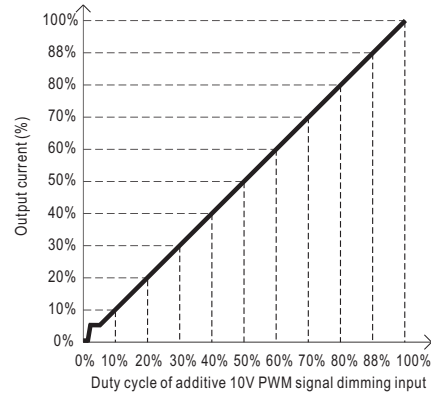
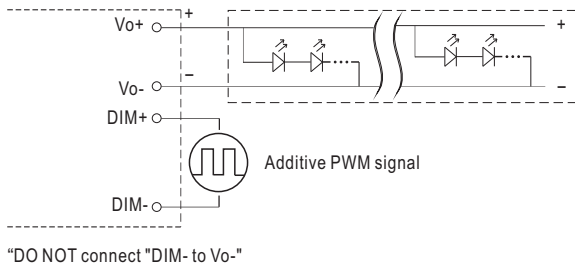

◎ Applying additive resistance:

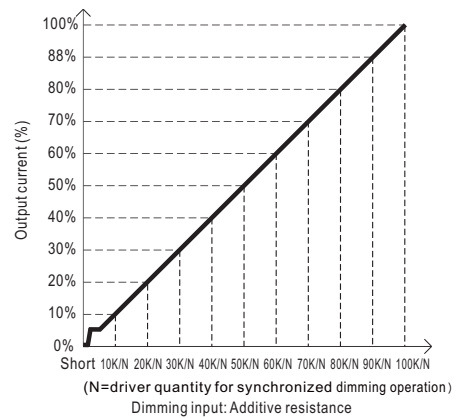
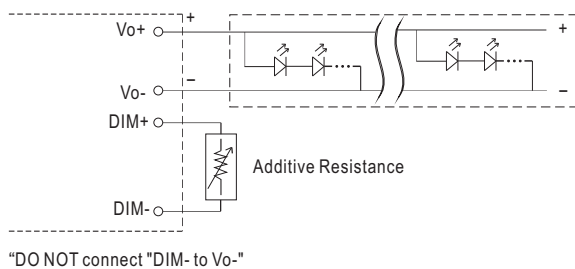

Note : 1. Min. dimming level is about 8% and the output current is not defined when 0% < I_{out} < 8%.
 2. The output current could drop down to 0% when dimming input is about 0k Ω or 0Vdc, or 10V PWM signal with 0% duty cycle.

OUTPUT LOAD vs TEMPERATURE

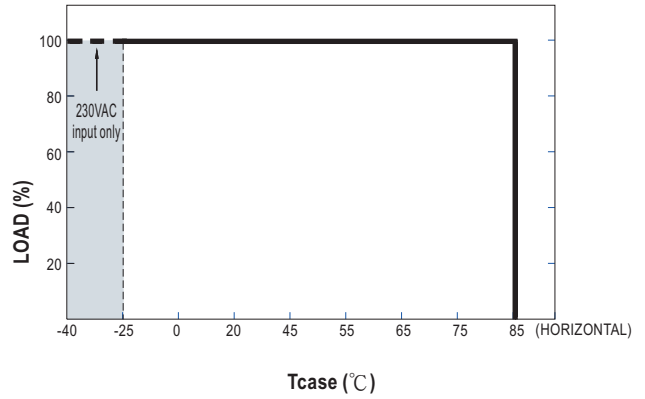
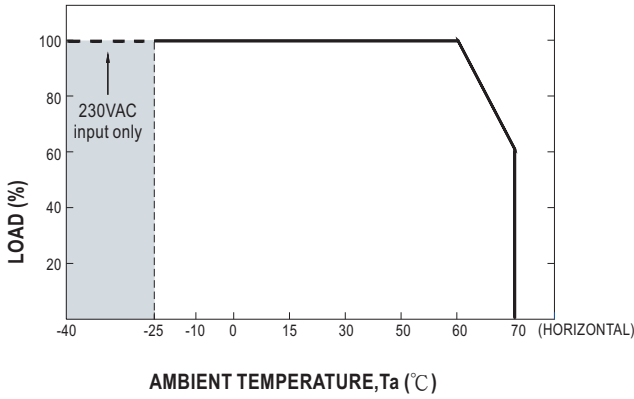

STATIC CHARACTERISTIC

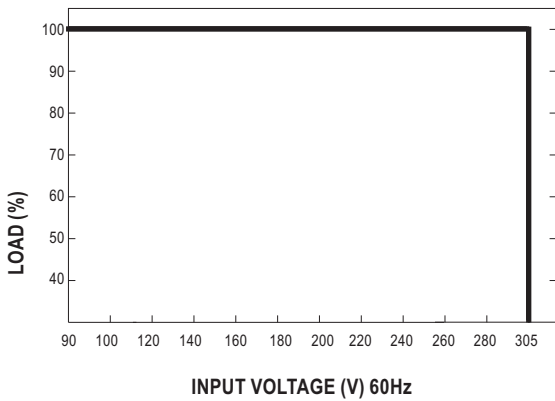

※ De-rating is needed under low input voltage.

POWER FACTOR (PF) CHARACTERISTIC

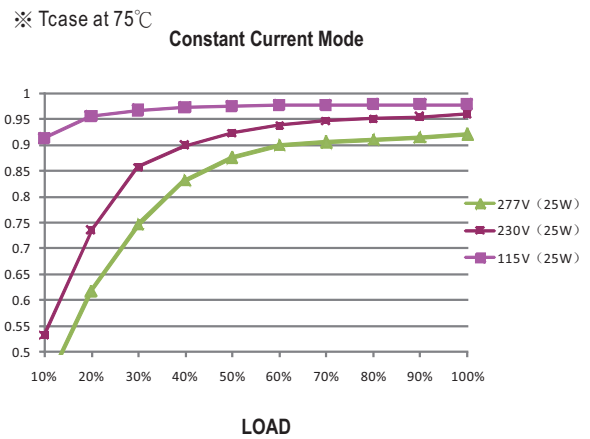

TOTAL HARMONIC DISTORTION (THD)

※ 50V Model, Tcase at 75°C

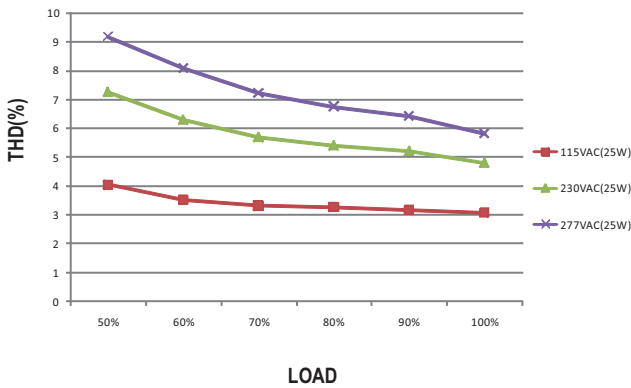

EFFICIENCY vs LOAD

XLG-25 series possess superior working efficiency that up to 88% can be reached in field applications.

※ 50V Model, Tcase at 75°C

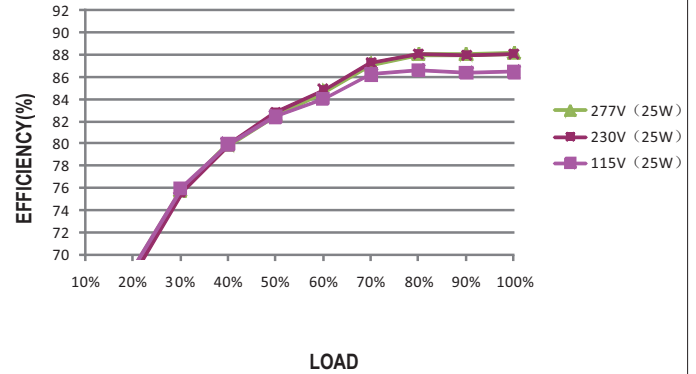

■ LIFE TIME

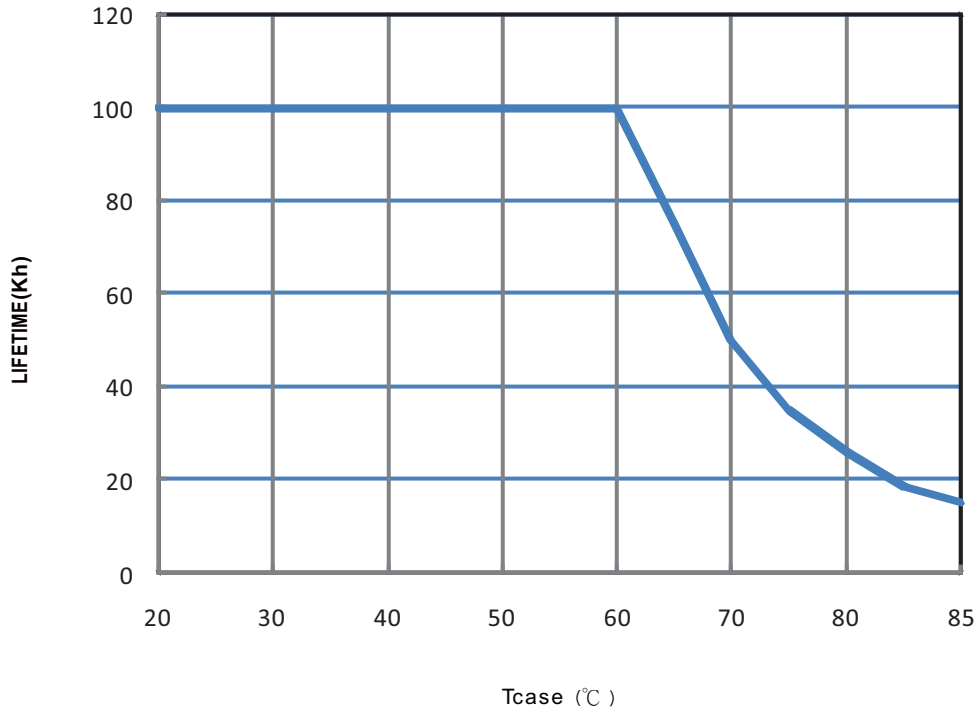

■ Mechanical Specification

※ A-Type

CASE NO.: 268A

Unit:mm

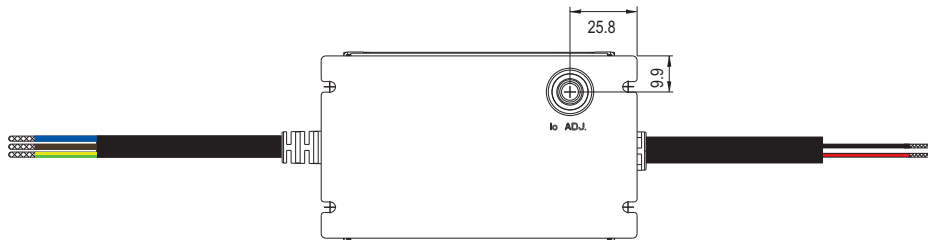
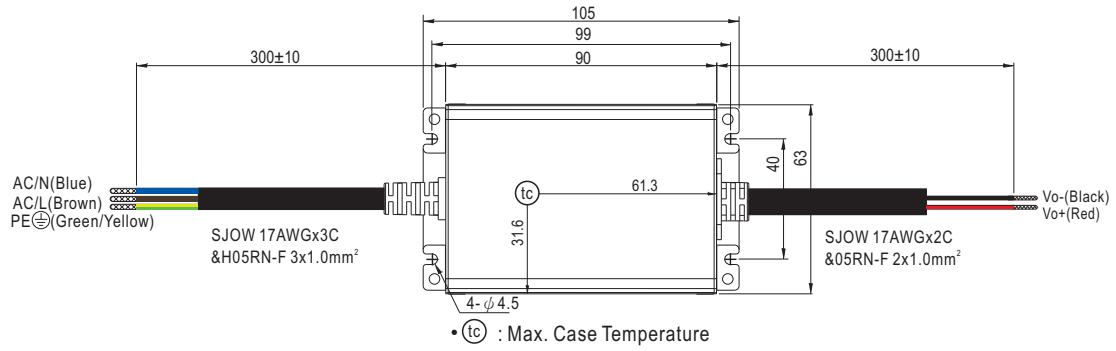

※ AB-Type

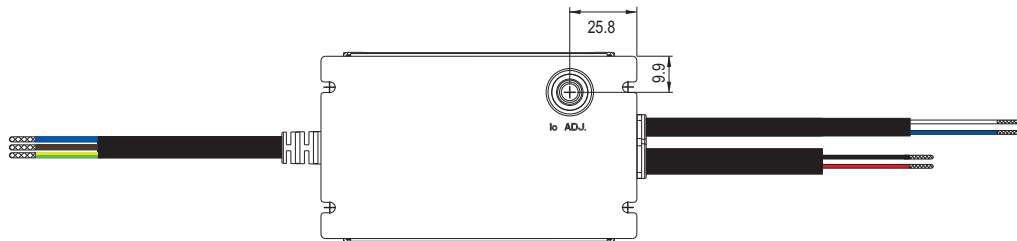
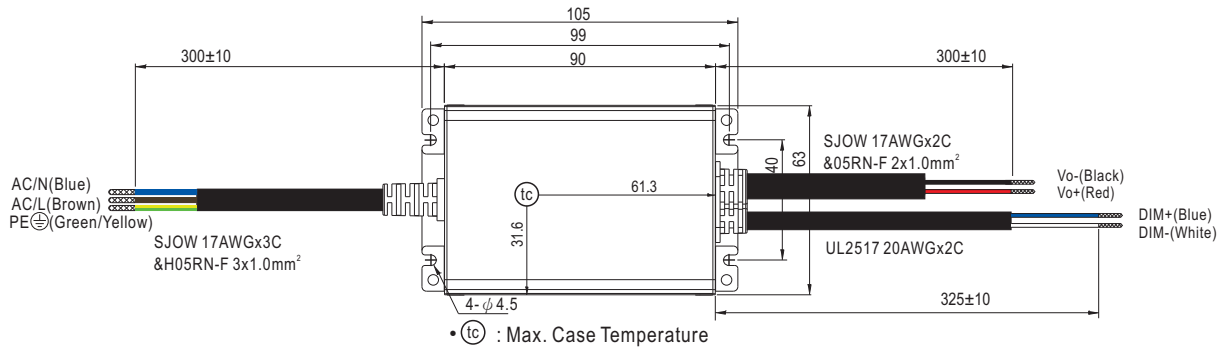

■ Installation Manual

Please refer to : <http://www.meanwell.com/manual.html>